

## Product lineup

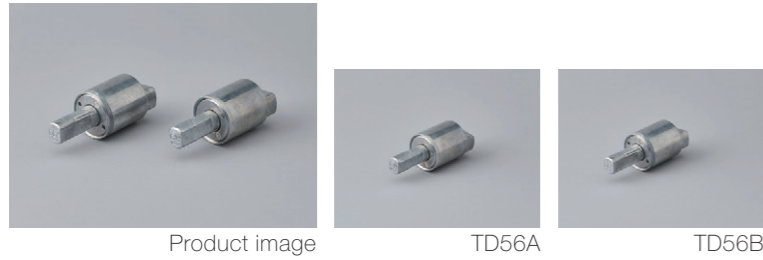

### Features

- High rigidity achieved by the use of zinc alloy
- Superior damping responsiveness
- The thin shaft
- Using the attachment, the form of TD56 will be the same as TD99

Product name	Torque [N·m] (lb·in)	Damping direction
TD56A1-10K	0.98 (8.67)	CW
TD56A1-15K	1.47 (13.01)	
TD56A1-20K	1.96 (17.35)	
TD56A1-25K	2.45 (21.68)	
TD56A1-30K	2.94 (26.02)	

Product name	Torque [N·m] (lb·in)	Damping direction
TD56B1-10K	0.98 (8.67)	CCW
TD56B1-15K	1.47 (13.01)	
TD56B1-20K	1.96 (17.35)	
TD56B1-25K	2.45 (21.68)	
TD56B1-30K	2.94 (26.02)	

The products with the attachment have "-AT" at the end of the product name.

## Product specifications

### Durability

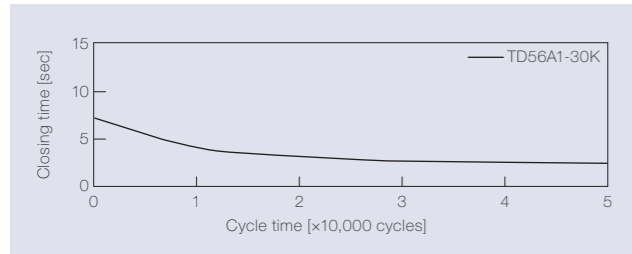

Torque	2.94 N·m (26.02 lbf·in)
Radial load	N/A
Angle range of closing time	70 to 0 deg.
Temperature	23 ± 2°C (73.4 ± 35.6°F)
Durability	50,000 cycles

### Temperature characteristics

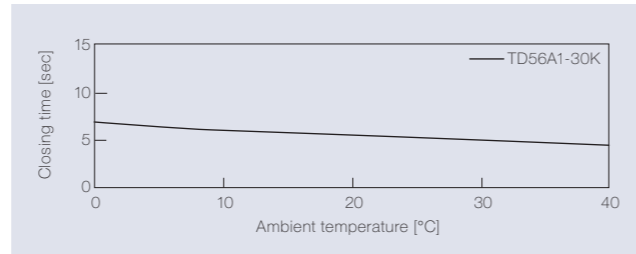

Measured according to the performance management testing method shown below after leaving in each designated ambient temperature for over one hour.

### Performance management testing method

As the torque of partial rotation angle dampers is not consistent, the closing time measurement jig is used for the performance tests.

[Operation during measurement]  
(Secures the housing of a rotary damper and moves its shaft)  
All rotary dampers are managed by the following closing time test.

Test mode [110° → 70° (Pause) → (Free fall with damping) → 0°]  
\* Horizontal plane: 0°

### Inspection specification before shipping

Type	Preset torque [N·m] (lb·in)	Closing time
10K	0.98 (8.67)	3 to 10 sec
15K	1.47 (13.01)	
20K	1.96 (17.35)	
25K	2.45 (21.68)	
30K	2.94 (26.02)	

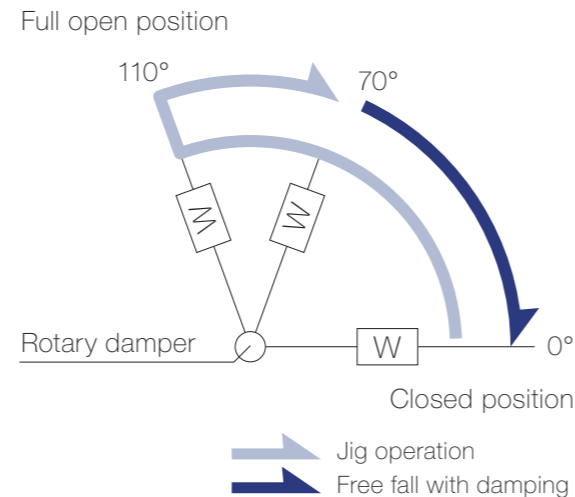

## Product information

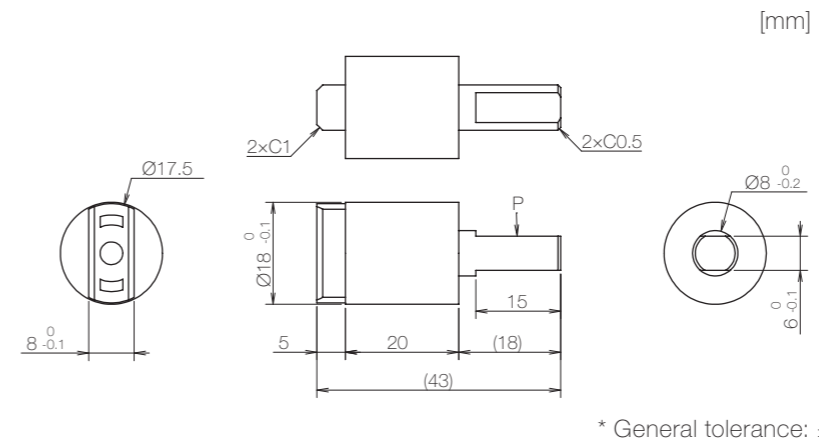

\* General tolerance:  $\pm 0.3$

- Opening angle: 110°
- Product weight: Approx. 30 g
- Allowable radial load (P): 29.4 N

### Main materials

Housing	Zinc alloy (ZDC)
Cap	Zinc alloy (ZDC)
Ring screw	Zinc alloy (ZDC)

## Dimensions related to mounting

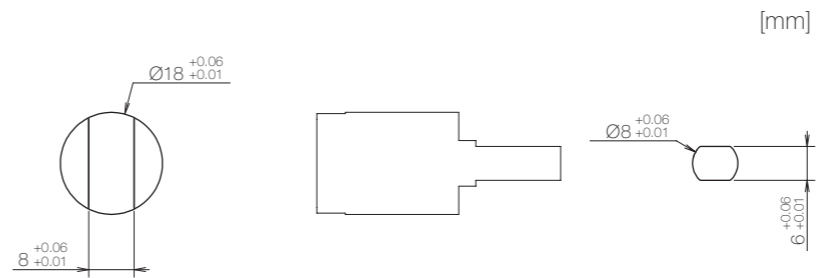

## Opening angle

### TD56A

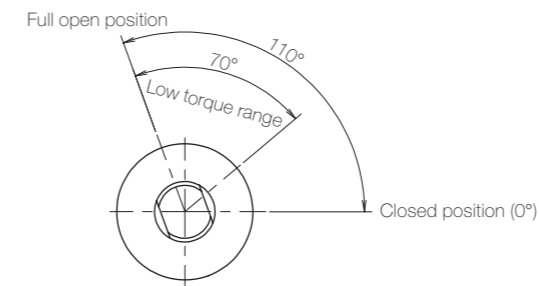

### TD56B

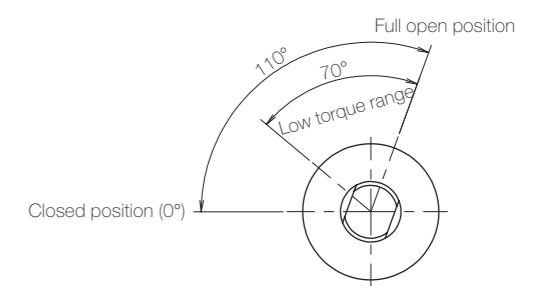

\* Shaft position at the time of shipping: Closed position

## Damping directions

### Rotation directions of the shaft to which torque is applied

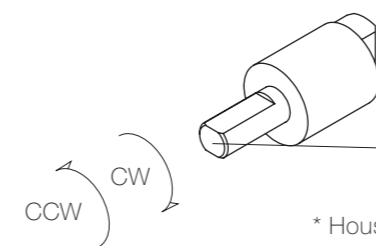

\* Housing secured / Shaft rotatable

Damping direction	Engraved mark
CW	CW
CCW	CCW